

TX-14B3T Operating Instruction

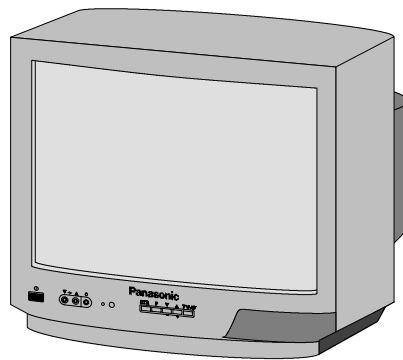

Panasonic



TX-14B3T

(U.K. Standard)

Please read these instructions completely before use and retain them for future reference.

Dear Panasonic Customer,

Welcome to the Panasonic family of customers. We hope that you have many years of enjoyment from your new colour television. The best way to understand the features of this television is to read this book thoroughly, before operating the set.

CONTENTS



● Warnings and Precautions	3
● Accessories	4
● Fitting Remote Control Batteries	4
● Installation and Set-up	5
● Location of Controls	7
● Menu Operation	8
● Teletext Operation	12
● Audio / Video Connections	13
● VCR and Satellite Receiver Installation	14
● VCR Operation	15
● Trouble-shooting	16
● General Information	16
● Specifications	17
● Scart Terminal Information	17

WARNINGS AND PRECAUTIONS

- This T.V. is designed to operate on A.C. 230 – 240V, 50Hz and is capable of receiving the PAL I transmission standard.
- Do not expose this TV set to rain or excessive moisture.
- **WARNING: HIGH VOLTAGE !**
Do not remove the rear cover, there are no user serviceable parts inside.
- Avoid exposing the TV set to direct sunlight or other sources of heat.
- Remove the mains plug from the wall socket when the TV set is not to be used for a prolonged period of time. Do not pull the power cable to remove the mains plug from the socket, always remove it by the plug.
- **CABINET AND PICTURE TUBE CARE**
Remove the mains plug from the wall socket. The cabinet and picture tube can be cleaned with a soft cloth moistened with mild detergent and water. Do not use solutions containing benzol or petroleum. TV sets can produce static electricity, care must be taken whenever touching the TV screen.
- Adequate ventilation is essential to prevent failure of electrical components. We recommend that a gap of at least 5cm is left all around this TV even when it is placed inside a cabinet or between shelves.

FOR YOUR SAFETY PLEASE READ THE FOLLOWING CAREFULLY

This appliance is supplied with a fitted three pin mains plug for your safety and convenience. A 5 amp fuse is fitted in this plug. If the fuse is replaced then the replacement fuse must be 5 amp rated and should be approved by ASTA or BSI to BS1362.

Check for the ASTA mark  or the BSI mark  on the body of the fuse.

If the fitted plug has a removable fuse cover you must ensure that it is refitted when the fuse is replaced. If you lose the fuse cover the plug must not be used until a replacement cover is obtained.

Replacement fuse covers can be purchased through your local Panasonic dealer.

The plug fitted to this appliance incorporates a mains filter circuit. If this is removed or replaced with a non-filtered mains plug this television will no longer meet the European standards for Electromagnetic Compatibility (EMC). If the fitted plug is unsuitable for the socket outlet in your home an appropriate adapter should be used.

Nonetheless, if the fitted plug is replaced, the fuse should be taken out and the cut-off plug disposed of safely. There is danger of severe electrical shock if the cut off plug is inserted into any 13amp socket.

If a new plug is to be fitted please observe the wiring code as shown below.
If in any doubt please consult a qualified electrician.

How to replace the fuse :

Lift out the removable fuse compartment with a screwdriver and replace the fuse, then refit securely into the mains plug.

IMPORTANT :- The wires in the mains lead of this appliance are coloured in accordance with the following code :-

BLUE : NEUTRAL

BROWN : LIVE

As the colours of the wires in the mains lead of this appliance may not correspond to the markings identifying the terminals in your plug, proceed as follows :-

1. The **BLUE** wire must be connected to the terminal marked 'N' or coloured black.
2. The **BROWN** wire must be connected to the terminal marked 'L' or coloured red.

IMPORTANT NOTE: Under no circumstances should either of these wires be connected to the Earth terminal of the three pin plug, marked with the letter 'E' or the earth symbol ().

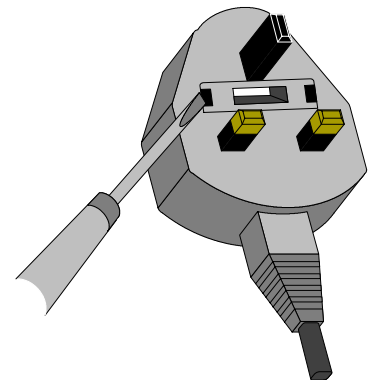

Important Note :
The layout of the mains plug used may differ from this illustration.

ACCESSORIES

Check that you have the accessories and items shown

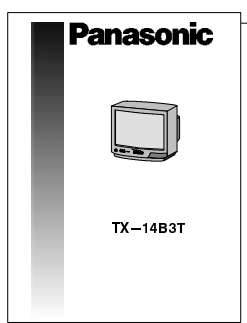

Operating Instruction book



TV Guarantee

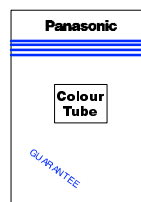

CRT Guarantee



Questionnaire

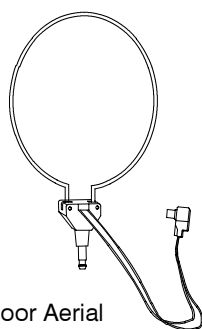

Indoor Aerial
TSA8E003

Remote Control Transmitter
EUR51851



Batteries for the
Remote Control Transmitter.
(2 x R6 (UM3) size)

FITTING REMOTE CONTROL BATTERIES

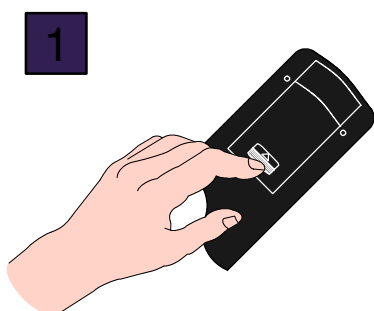

Slide off the battery cover

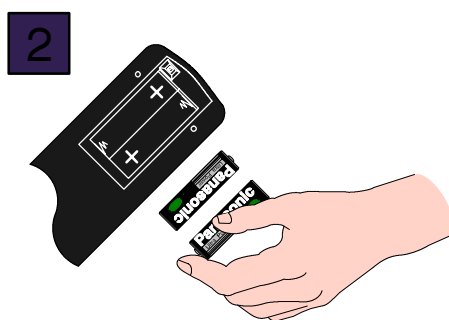

Insert batteries – note correct polarity

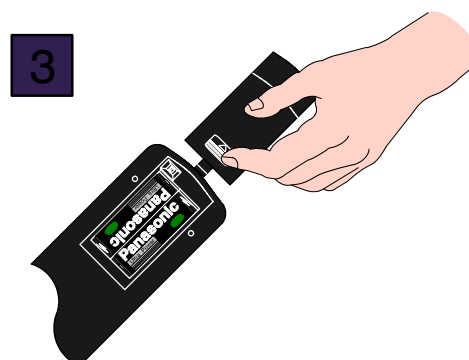

Replace the cover

- Make sure that the batteries are fitted the correct way round.
- Do not mix old batteries with new batteries. Remove old, exhausted batteries immediately.
- Do not mix different battery types, i.e. Alkaline and Manganese. Do not use rechargeable (Ni-Cad) batteries.

INSTALLATION AND SET-UP

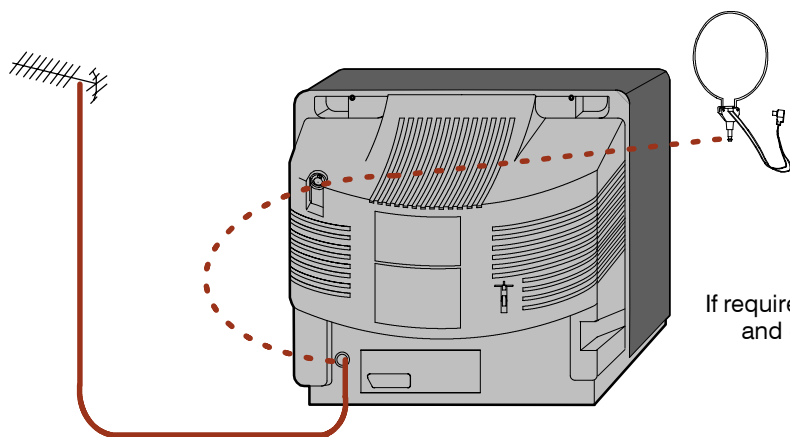

1

TV only

Connect Aerial co-axial cable direct to TV RF IN socket.

If required, insert the indoor aerial into the case socket and connect the cable to the TV RF IN socket.

OR

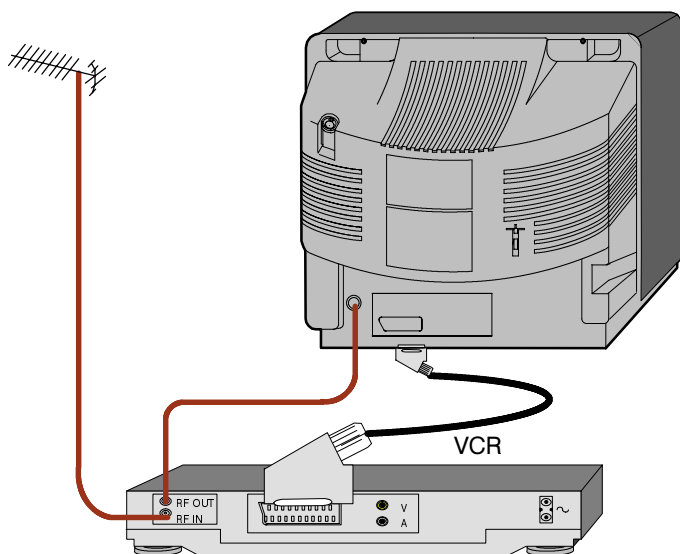

USING A VCR

Connect aerial co-axial cable to RF Input socket of VCR and a RF co-axial cable from VCR RF Out socket to TV RF IN socket.

The VCR can also be connected to the TV using a SCART to SCART lead.

Further details of Audio/ Video connections can be found on page 13.

OR

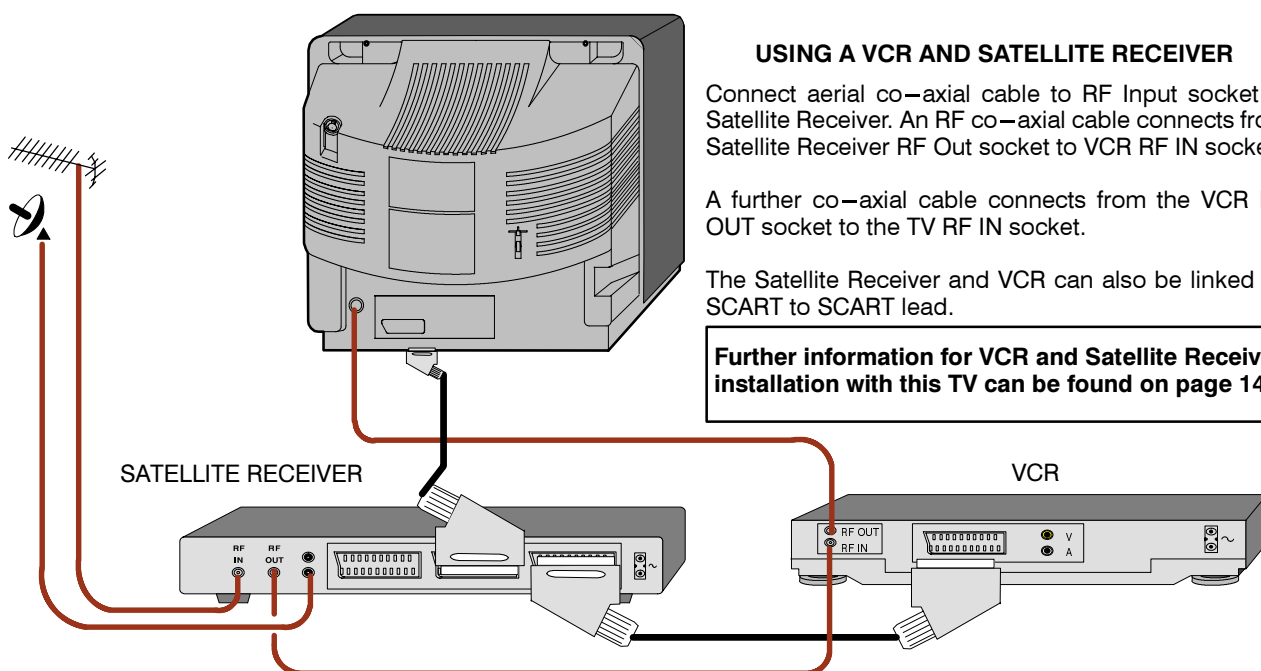

USING A VCR AND SATELLITE RECEIVER

Connect aerial co-axial cable to RF Input socket of Satellite Receiver. An RF co-axial cable connects from Satellite Receiver RF Out socket to VCR RF IN socket.

A further co-axial cable connects from the VCR RF OUT socket to the TV RF IN socket.

The Satellite Receiver and VCR can also be linked by SCART to SCART lead.

Further information for VCR and Satellite Receiver installation with this TV can be found on page 14.

Ancillary equipment and leads are not supplied.

INSTALLATION AND SET-UP

2

Switch ON your VCR (if connected).
Switch ON your Satellite Receiver (if connected).^{*1}
Plug the TV into a mains socket and switch ON.
Programmes will appear immediately if your dealer has already tuned the TV for you.

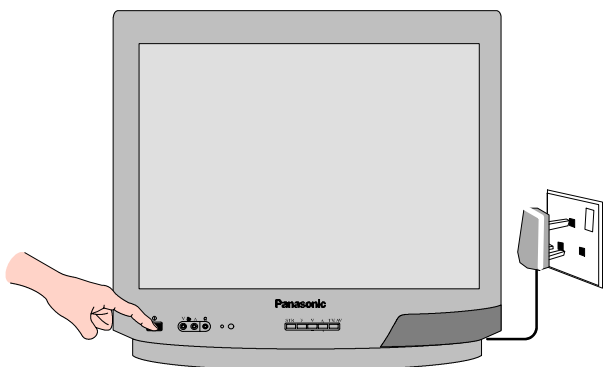

3

If the TV has not been tuned for you then **Auto setup** will begin. TV stations will be located, sorted and stored. ^{*2}

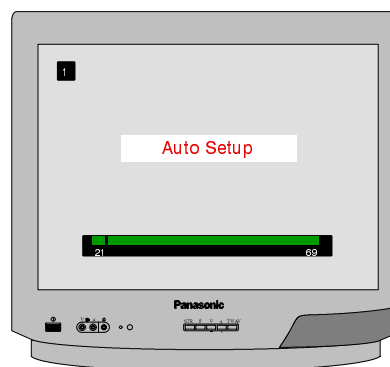

4

The first available channel will be displayed.
Press "N" key to normalize all settings.

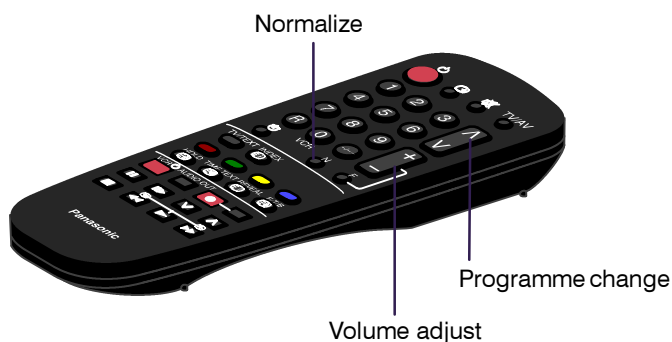

*1. The Satellite Receiver must be tuned to either SKY ONE or SKY NEWS before starting Auto Setup. When Auto Setup has finished, the satellite position that has been stored will be listed as 'SAT'.

*2. The sorting order depends upon the TV signal, the broadcasting system, and reception conditions. If either BBC1, BBC2 or ITV are not located, then their respective pre-allocated programme positions (1 to 3) will remain unused.

Programme Position	All stations available	No CH5	No CH5 / S4C	No CH4 / CH5	No S4C	No CH4 / S4C	No CH4 / S4C / CH5
1	BBC1	BBC1	BBC1	BBC1	BBC1	BBC1	BBC1
2	BBC2	BBC2	BBC2	BBC2	BBC2	BBC2	BBC2
3	ITV	ITV	ITV	ITV	ITV	ITV	ITV
4	CH4	CH4	CH4	S4C	CH4	CH5	SAT
5	S4C	S4C	SAT	SAT	CH5	SAT	●
6	CH5	SAT	●	●	SAT	●	●
7	SAT	●	●	●	●	●	●

Note :

● The next available channel will appear, if no other stations are available then the Programme position will remain unused.

If the order is not to your preference it can be rearranged. Refer to the Tuning menu Swap feature – see page 11 for details.

IT IS IMPORTANT that you only use TV programme position '0' to view your VCR. If your VCR picture does not appear on programme position '0' (the VCR position), refer to page 14 for guidance.

LOCATION OF CONTROLS

On Screen Displays

Menu Title _____
 Cursor Bar _____
 Sub Menu _____

Commands : _____
 A guide to the various options available when in On Screen Menu operations.

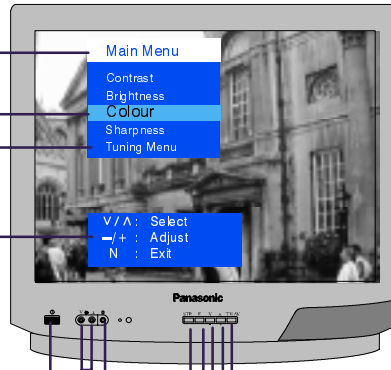

Front Panel Controls

Mains Power On/Off switch _____

Note :
 If the power supply is interrupted e.g. mains plug removed from socket outlet, then the red light indicating standby may be on for a short period of time.

RCA Audio/Video sockets _____

Headphone socket _____

TV / AV
 Switches between TV and AV modes

∇ / ←, ^ / +
 Programme up / down.
 When a function is already displayed, allows adjustment of the function.

F
 Selects a function from :
 Volume, Contrast, Brightness, Colour, Sharpness and Manual Tuning.

STR
 Stores tuning and other function settings

Remote Control keys

Numeric keys for :
 Programme change
 Teletext operation

Switches between the current and last programme positions

Off timer
 Press to select from 30, 60 or 90 minutes

Teletext keys (Page 12)

VCR keys (Page 15)

Restores the levels previously set with STR (TV front panel)

Standby On/Off

Status : Displays programme position, channel number and teletext station name

Sound mute On/Off

Switches between TV and AV modes (Page 13)

Channel up/down and Menu option select

Adjusts currently selected function. Adjusts the volume if no function is selected

Selection of programmes 10–70 using numeric keys

Function Select
 Press to display the On Screen Menus (Page 8)

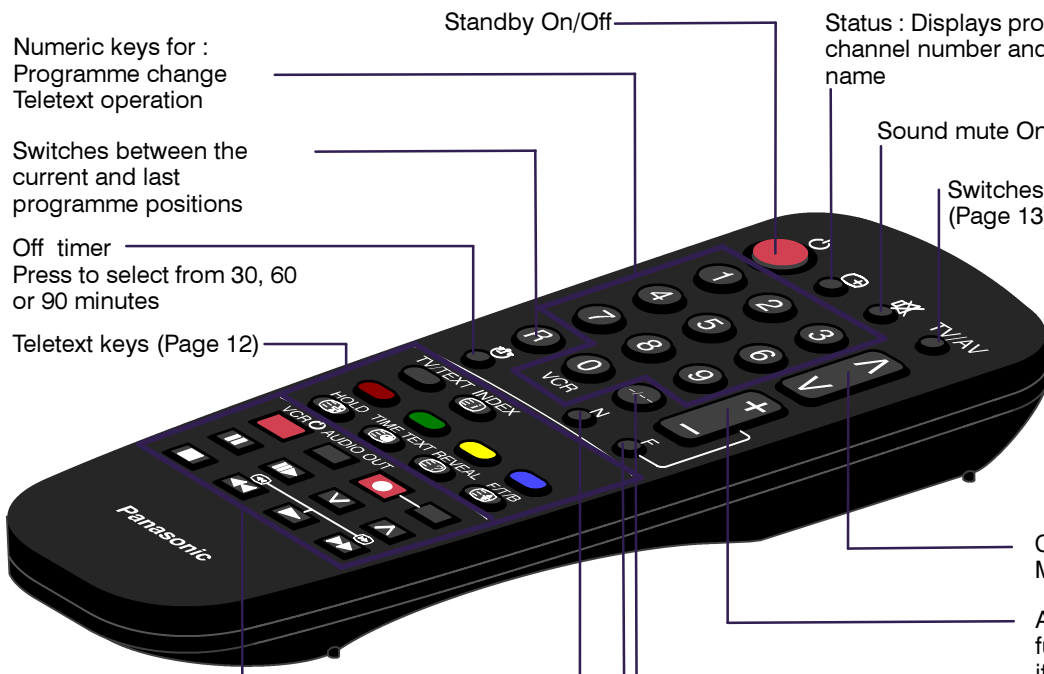

MENU OPERATION

Menu operation is to be used in conjunction with the On Screen Display commands to guide you through function adjustments and tuning operations

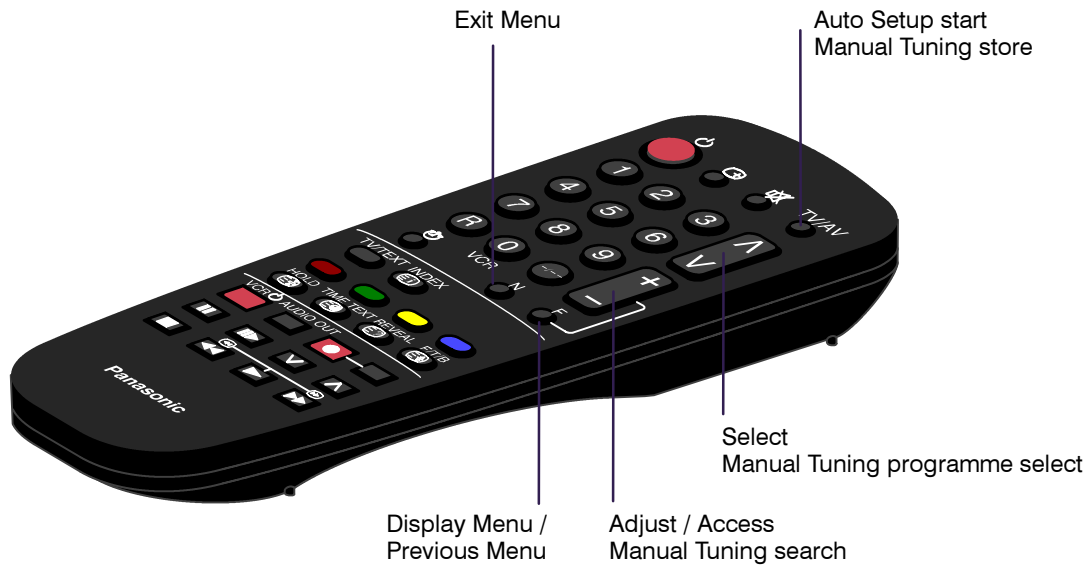

Main Menu

- Contrast
- Brightness
- Colour
- Sharpness

The Contrast, Brightness, Colour and Sharpness may be altered to suit the viewing conditions and personal preferences.

Display Menu

Select function and adjust

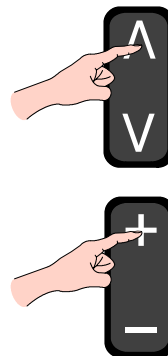

Tuning Menu

The Tuning menu provides access to both manual and automatic tuning menus.

Display Menu and select "Tuning Menu"

Access "Tuning Menu"

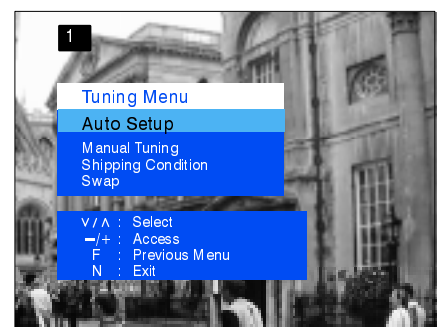
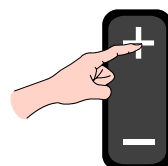
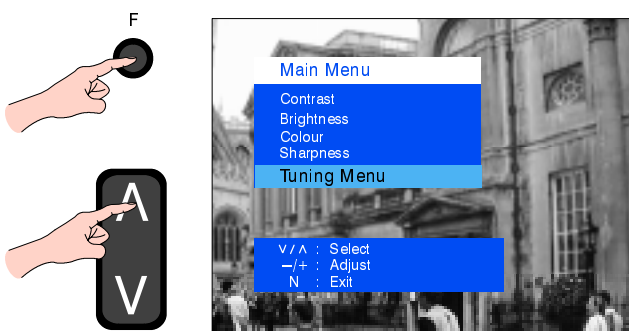

MENU OPERATION

Auto Setup

The Auto Setup menu allows you to automatically retune the TV, particularly useful if you move to an area that is served by a different transmitter.

First access the Tuning menu as described on Page 8.

1 Access "Auto Setup"

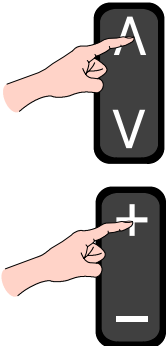
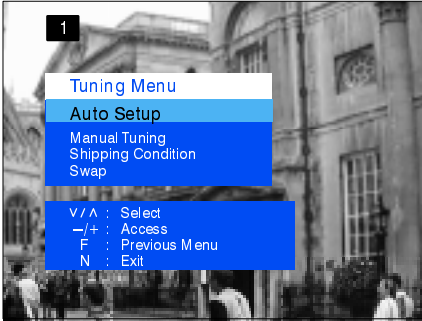
2 Start

3 Confirm Start

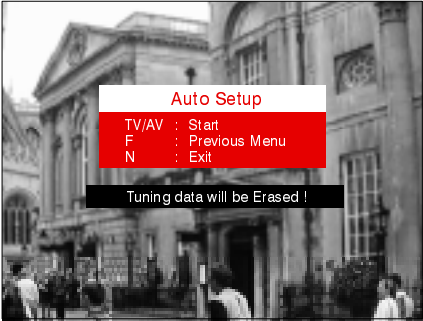
4 Ready to go

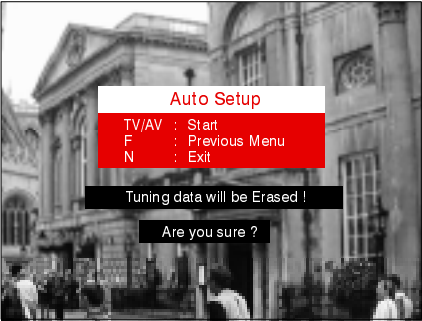

Manual Tuning

The Manual tuning menu allows individual programme positions to be tuned manually.

First access the Tuning menu as described on Page 8.

Access "Manual Tuning"

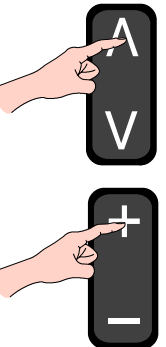
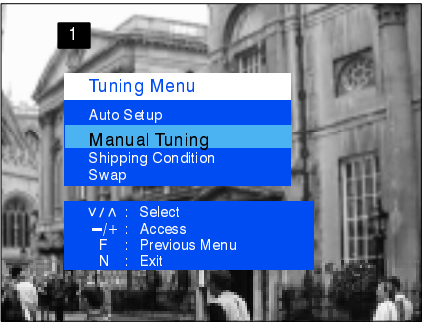
1. Choose programme position

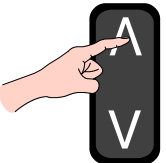

2. Search for channel

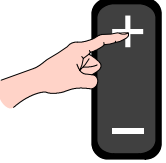

3. Store



Repeat steps 1 to 3 as necessary to store other channels

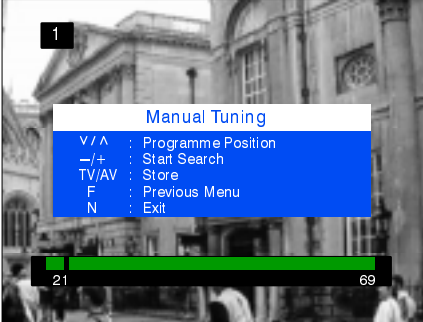

MENU OPERATION

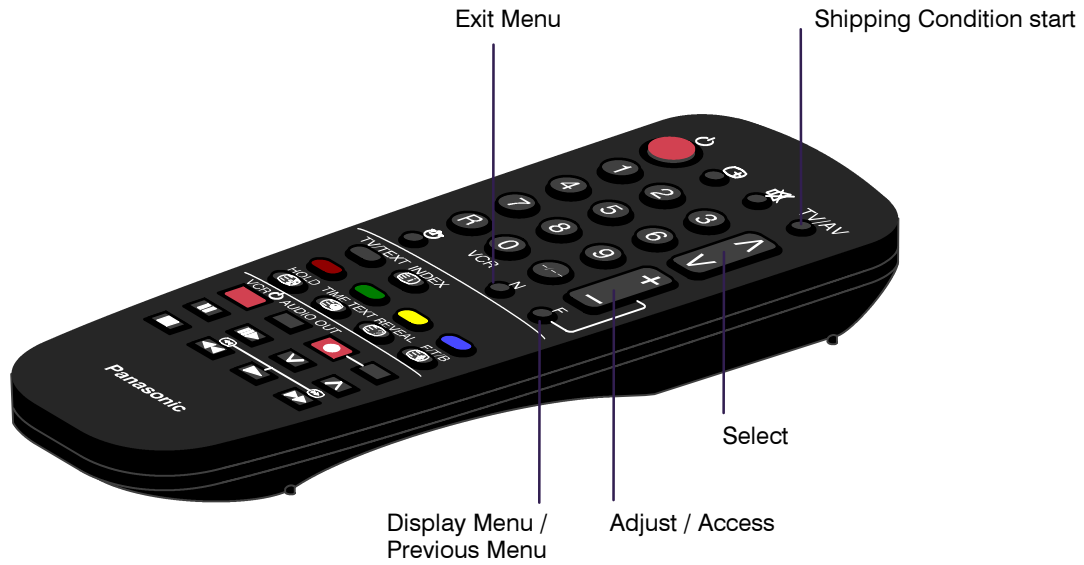

Shipping Condition

Allows you to clear all tuning information and reset all control levels back to the factory settings.

First access the Tuning menu as described on Page 8.

1

Access "Shipping Condition"

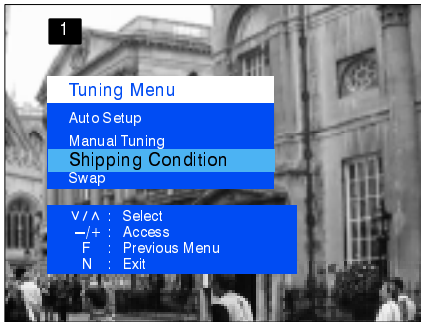
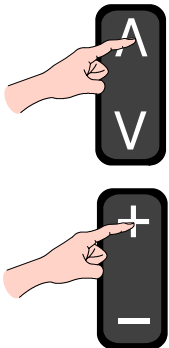

2

Start

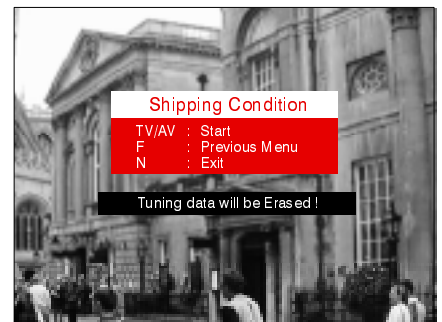

3

Confirm Start

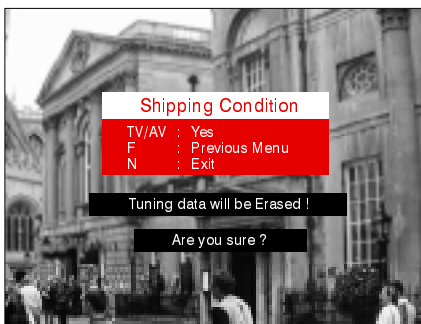

4

Ready for Auto Setup or Manual Tuning.

Refer to Page 9.

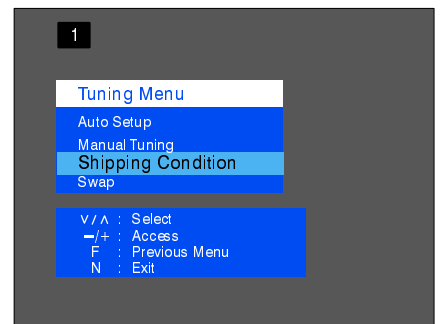

MENU OPERATION

Swap

If the programme order after Auto Setup is not to your preference you can swap programmes between positions.

An example could be for regional variations, e.g. BBC1 Wales and BBC1 West, where you may want to swap them so that BBC1 West appears on programme position 1.

First access the Tuning menu as described on Page 8.

Access "Swap"

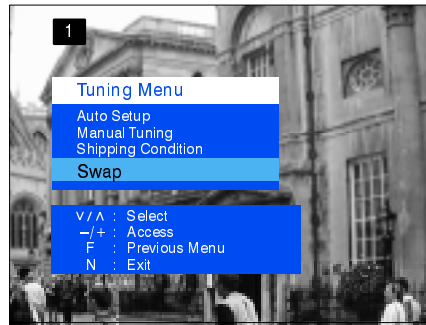
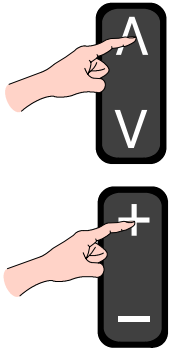

Swap programmes

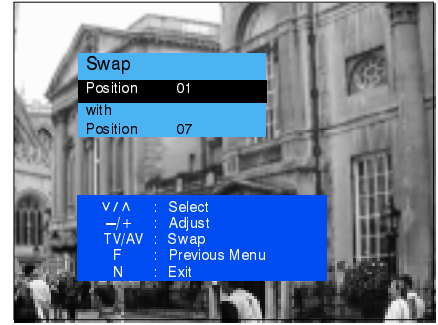

Manual Tuning (front panel of the television)

The stations may also be manually tuned using the controls on the front of the television.

Press the F key (Front panel) until "Manual Tuning" is reached. Press - or + to access "Manual Tuning".

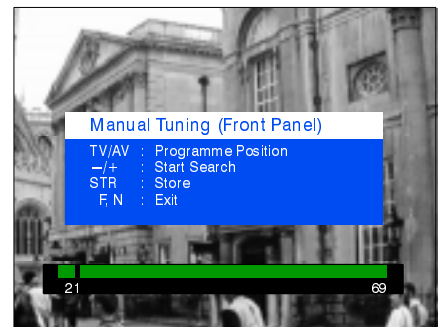
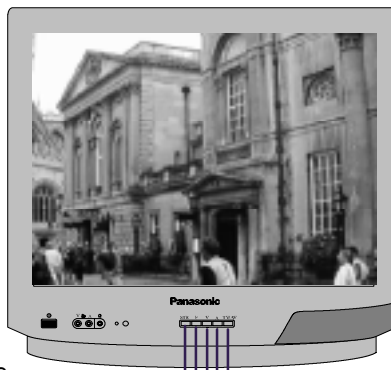

Store
Function select / Exit
Change programme position
Search

TELETEXT OPERATION

Teletext is the broadcasting of pages of information on your T.V. screen containing various subjects, the order and availability of which is dependant upon the Broadcasting Companies.

If the Function Select key (F) is pressed whilst in Teletext operation, only the Contrast can be adjusted. It is not possible to adjust the Brightness function when in Teletext operation.

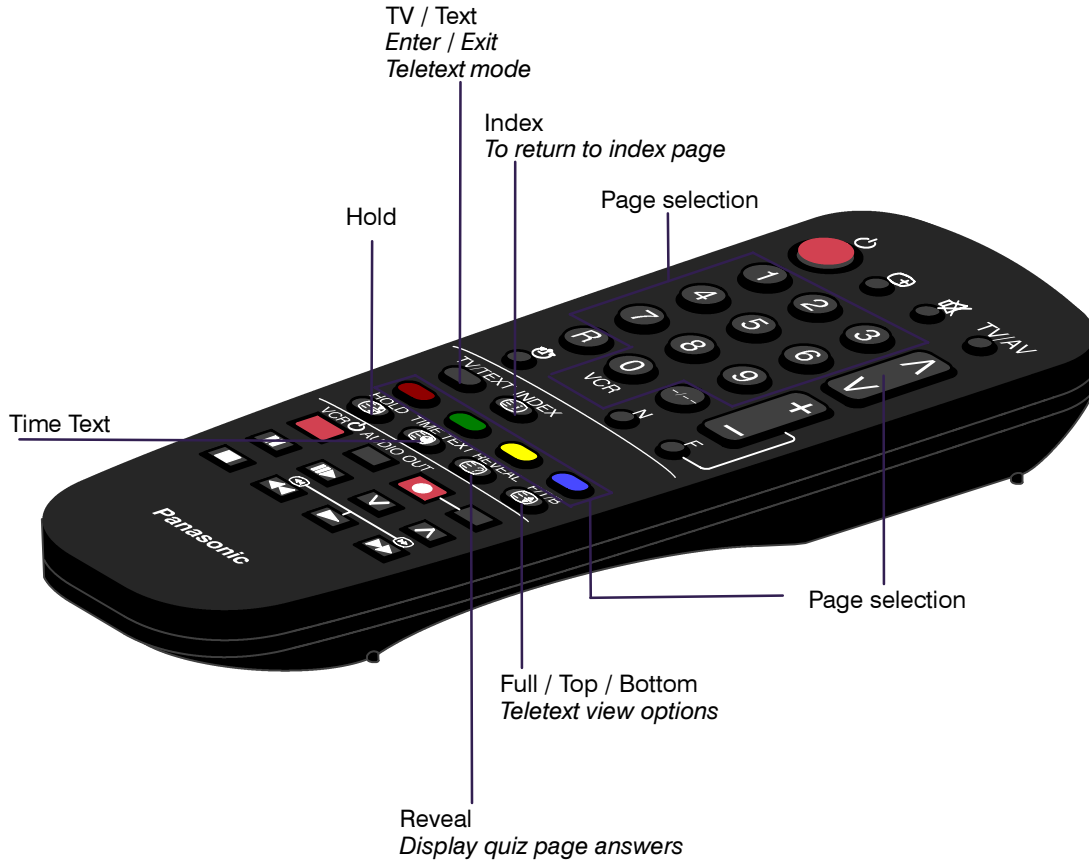

FASTEXT / Normal Automatic Selection

On switching to Teletext, normal mode will be displayed whilst a search is performed for FASTEXT transmissions, if one is found, the boxes at the bottom of the screen will change to show the available subjects.

If a FASTEXT signal is not found then the TV will operate in Normal mode whereby the :

- Red key moves one page down.
- Green key moves one page up.
- Yellow key moves up in blocks of ten pages.
- Blue key moves up in blocks of 100 pages.

Index

In FASTEXT mode, returns to the relevant index page. Depending on the way information is transmitted, this may have to be pressed more than once to return to the main index page.

Red / Green / Yellow / Blue keys

Correspond to the FASTEXT or Normal mode coloured boxes.

Sub Page Access (Time Text key)

When teletext information exceeds more than one page, it may take some time for the automatic changing of the sub pages to reach the sub page you require. It is possible to enter the required sub page and skip the pages in between.

Select the required page number using keys 0 – 9.

Press **TIME TEXT**.

Press **RED (-)** or **GREEN (+)** to select the required sub page.

When the page is found, it will be displayed.

Press **TV/TEXT** to exit Teletext operation.

AUDIO / VIDEO CONNECTIONS (FRONT OR REAR)

AV (Audio / Video) is a dedicated input for VCR's, Satellite Receivers and other Audio / Video equipment. This TV is capable of switching to AV operation automatically if the equipment connected provides a switching signal to the SCART socket.

In this condition the display will show EC and it is possible to change the programme position of the TV without changing the displayed picture (this is not possible when using the front AV connections).

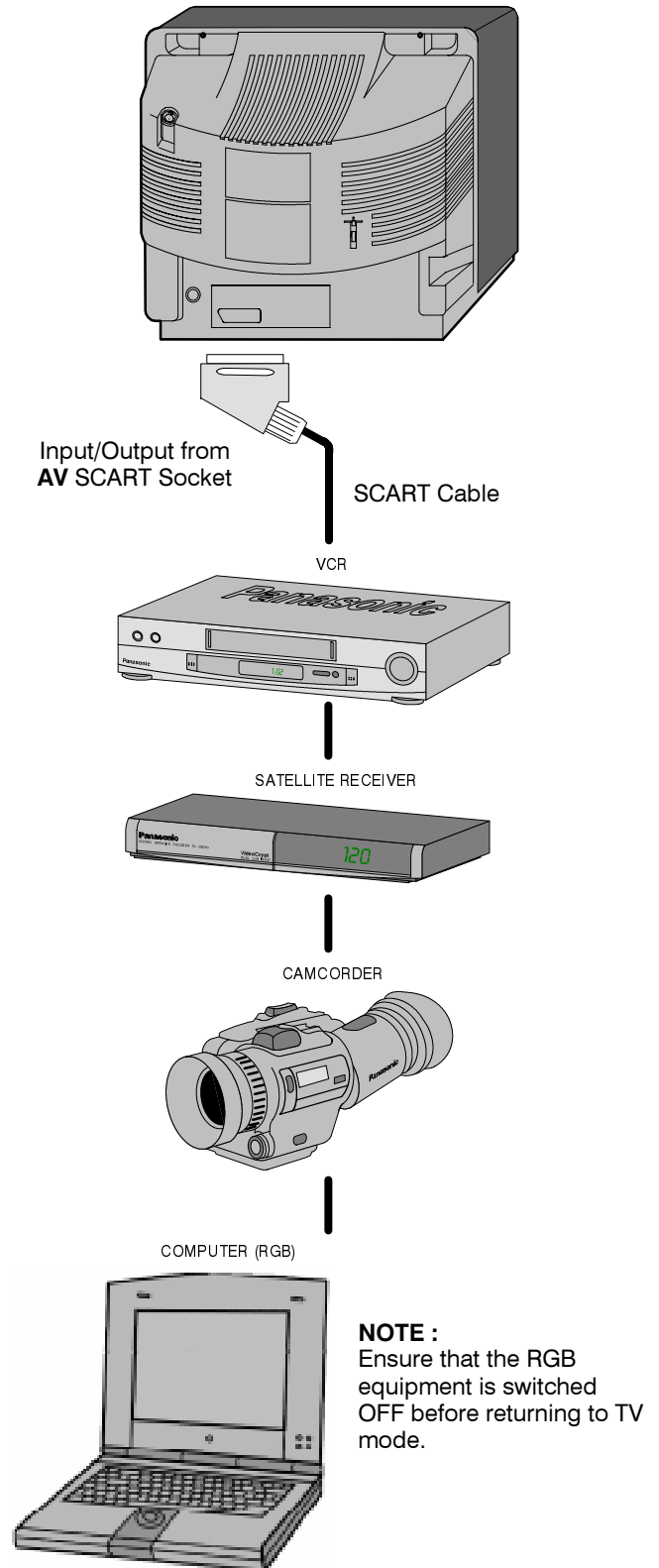
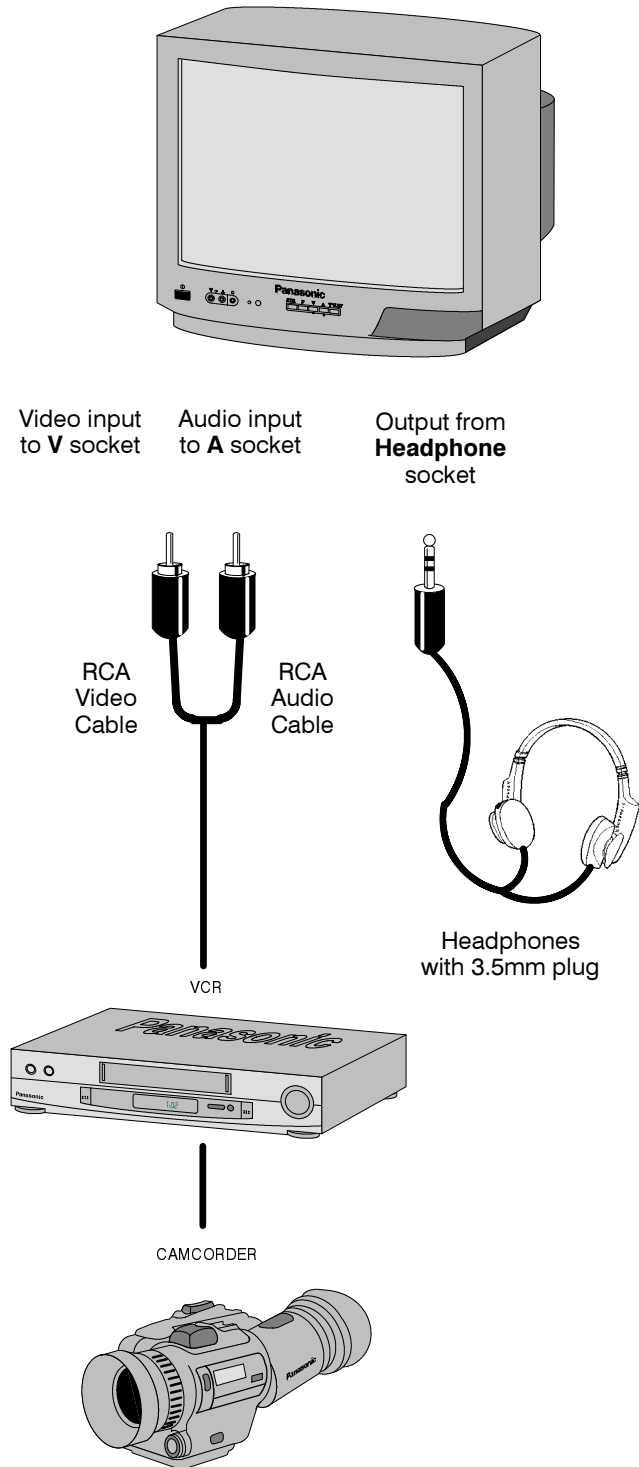

Ancillary equipment and cables shown are not supplied with this TV set.

Do not connect a computer with TTL output (5V) to this TV set.

The TV's speaker will be automatically disconnected whilst the headphones are connected.

Do not connect front and rear AV inputs simultaneously, as the sound and pictures will be mixed.

VCR AND SATELLITE RECEIVER INSTALLATION

Your new TV is supplied with programme position '0' set to receive an RF signal from a VCR.

However, if for some reason the VCR is tuned to a different RF channel then you will not receive any picture or sound from the VCR on programme position '0' of the TV. It will be necessary to either adjust the RF channel of the VCR or to adjust the tuning of the TV's programme position '0' or both until the RF output channel of the VCR is received.

It is intended that this advice is used in conjunction with the instruction books for your ancillary equipment.

TO TUNE YOUR VCR TO THE TV

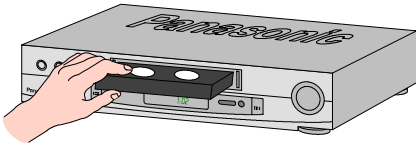

RF CHANNEL ADJUST

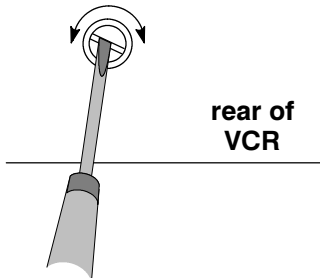

Note :
Some VCR's are capable of adjusting their RF channel via their remote control unit.



Insert recorded tape and select playback

Set TV to programme position '0' VCR

Adjust tuning

Operation completed

See below for installation of VCR and Satellite Receiver

TO TUNE YOUR TV TO THE VCR

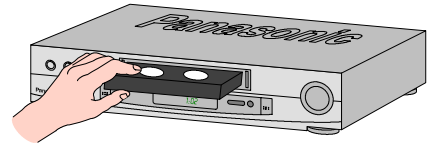

Access the Manual tuning menu as detailed on page 9.

Programme position and current channel are displayed top left of screen

∇ ∆ To select programme position '0'
- + To start search for VCR playback

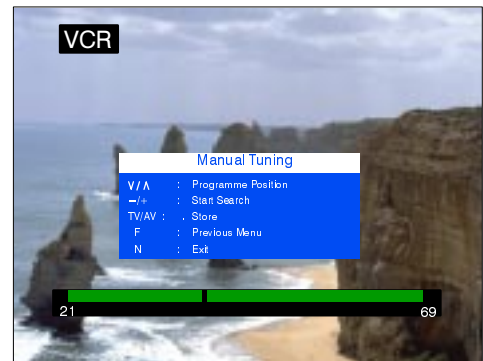

To store position

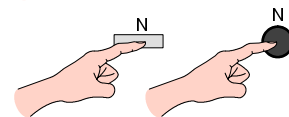

To return to viewing screen

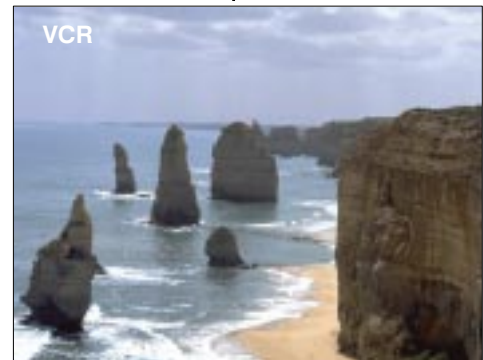

If you are going to use a Satellite Receiver and a VCR, it is important, to avoid tuning problems, that they are both tuned to output their signals on different channels. For example, if your VCR is tuned to output channel 32, your Satellite Receiver could be set to output channel 34. Refer to your Satellite Receiver and VCR instruction books for precise tuning information.

VCR OPERATION

The Remote Control is capable of operating some functions of selected Panasonic VCR's, please consult your dealer for details. Some VCR's have different functions, so to ensure compatibility please refer to the VCR's instruction book.



VCR Standby



Still Advance
frame by frame when in
PAUSE / STILL mode.



Pause / Still



Stop



Rewind / Review

AUDIO OUT



If a Stereo Hi-Fi VCR is connected to this TV, press this key to select the sound output required.



Play



Record
Press together



Fast Forward / Cue



VCR programme up / down

TROUBLE–SHOOTING

Before calling for service, determine the symptoms and make a few simple checks as shown below. For service please contact your local Panasonic dealer quoting the model number and serial number (both are located at the rear of the TV).

Symptoms		Checks
Picture	Sound	
Snowy Picture or Multiple Images	Noisy Sound or Normal Sound	Aerial location, direction or connection
Interference	Noisy Sound	Electrical appliances, vehicles, fluorescent lights
Normal Picture	Noisy or No Sound	Volume level or sound muted
No Picture	No Sound	Not plugged into A.C. outlet, not switched on picture / sound controls set at minimum levels
No Colour	Normal Sound	Colour controls set at minimum levels
Scrambled	Normal or Weak Sound	Retune channel(s)

GENERAL INFORMATION

Sleep Feature

If the set is not switched off when the TV station stops transmitting, it will automatically go to standby mode after 30 minutes. This function will not operate when in AV mode.

Last Position Memory

Certain functions have a last position memory, i.e. the setting at the time of switch off will be the setting used when the receiver is switched on again:

Programme position	Colour	Volume
Contrast	Brightness	Standby
Sharpness	Status	

TV Games / Home Computers

Extended use of TV games or home computers with any television set can cause a permanent 'shadow' on the screen. This type of irreversible picture tube damage can be limited by observing the following points :

- Reduce the brightness and contrast levels to a minimum viewing level.
- Do not operate the television set for a continuous period of time while using TV games or home computers.

This type of picture tube damage is not an operating defect and as such is not covered by the Panasonic warranty.

SPECIFICATIONS

Model Number : TX-14B3T

Power Source : 230 – 240V 50Hz A.C.

Power Consumption : 39W

Standby Power Consumption : ... 9W

Picture Tube : 34cm visible diagonal

Audio Output (Music) : 3W, 16Ω impedance, Mono

Dimensions : 338 (H) x 366 (W) x 373 (D) mm

Weight : 9.9 kg

Receiving Systems : **PAL I**
PAL 525/60

UHF E21-69
 Playback of NTSC tape from PAL Video recorders (VCR)

Aerial – rear : UHF

Headphones – Front : 3.5mm, 16Ω impedance, Mono

AV – Rear : 21 pin terminal – Audio/Video in/out, RGB in

AV – Front : RCA Audio in/RCA Video in

Design and specifications are subject to change without notice.
 Weight and dimensions shown are approximate.

SCART TERMINAL INFORMATION

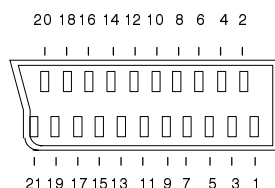

- | | | | |
|-----|---------------|-----|------------------|
| 1. | Audio out (R) | 12. | -- |
| 2. | Audio in (R) | 13. | Red earth |
| 3. | Audio out (L) | 14. | Ground |
| 4. | Audio earth | 15. | Red in |
| 5. | Blue earth | 16. | Status RGB |
| 6. | Audio in (L) | 17. | CVBS earth |
| 7. | Blue in | 18. | RGB Status earth |
| 8. | Status CVBS | 19. | CVBS out (video) |
| 9. | Green earth | 20. | CVBS in (video) |
| 10. | -- | 21. | Socket earth |
| 11. | Green in | | |

Panasonic (U.K.) Ltd
Willoughby Road,
Bracknell,
Berks.
RG12 8FP